



Swing Sets

100% CEDAR



Creating Childhood Memories Since 1992!

Reasons Why Eastern Jungle Gym® is ***THE BEST!***

Since 1992, Eastern Jungle Gym® has been providing safe, high quality and affordable swing sets that last for years. Our variety of models, unmatched craftsmanship and great value has earned us the confidence of thousands of customers.



- 1:** All construction is **100% Cedar** (*C. lanceolata*). Because cedar is naturally resistant to rot and insect damage, no chemical treatment is necessary to preserve the wood (unlike other woods).
- 2:** **All Wood** is sanded, and edges and corners are rounded. Each piece is then factory stained before installation. This ensures a safe and long-lasting finish.
- 3:** Huge **4" x 6" and 4" x 4" Laminated Cedar Construction**, plus our Easy 1-2-3 **Steel Bracket System**, means you never rely on any single bolt or fastener alone. All our load-bearing points are double supported.
- 4:** **Heavy Duty Swing Hangers**—Our heavy-duty swing hangers are the safest and strongest. Made of steel and cast iron mounted with thru-bolts.



- 5:** We use **Lag Bolt & Wood Screw Fasteners**—never nails or staples! Lag bolts do not need re-tightening like carriage bolts or other through-bolt fasteners, so there's no need for annual maintenance or service.
- 6:** **Recessed Hardware** means that all bolts are countersunk for a safe and aesthetically-pleasing look. No caps! Exposed bolts can create a hazard for loose clothing to catch on.
- 7:** Straight coil **Swing Chain** is heated, primed, and **Plastisol-Coated** for a safe, smooth grip. No ropes or powder-coated chain!
- 8:** **Steel Ladder Rungs**—unmatched in strength and safety.
- 9:** **Wood step ladder rungs** for easier access—6-inch wide steps for sure footing.
- 10:** **Heavy Duty Slides**—sturdy wave slides with high side rails, and scoop slides with double-wall construction.



**Easy 1-2-3
Steel A-Frame
Bracket System**

ENGINEERED HEAVY-DUTY **CONSTRUCTION**

All swing beams and side supports are supported with **Easy 1-2-3 A-Frame Brackets**. Designed specifically for swing sets, these brackets are the strongest and safest support system on the market today! *Never rely on fasteners alone to support your swing set.*

**Never
Rely
on fasteners
alone to
support your
swing set!**



Find Your Swing Set Easy as 1-2-3!



Straight-Base Series

Vertical clubhouse structure accommodating optional built-in picnic table or bottom playhouse.



Angled-Base Series

A-frame design features a tire swing below the play deck.



Multi-Deck Series

Vertical, multiple play deck structure accommodating optional built-in picnic table or bottom playhouse.

Straight-Base Introduction	4-5
Dreamscape ® Models	6-7
Dream ® Models.....	8-11
Ultimate ® Models	12-13
Angled-Base Introduction	14-15
Supremescape ® Models.....	16-17
Supreme ® Models.....	18-19
Extreme ® Models.....	20-21
Multi-Deck Introduction	22-23
Sky ® Models	24-27
Sky ® Tree House Cabin Models.....	28-29
Fantasy ® Models.....	30-33
Fantasy ® Tree House Cabin Models	34-35
Imagination ® Models	36-38
Classic ™ Models.....	39
Add-Ons, Accessories, & Slides	40-41
Installation	42
Q & A, Warranty	43
About Us, Dealer Information	44

Straight-Base Series

**Our Original Design
Now Better Than Ever!**

The Straight Base Series features a straight vertical clubhouse structure which can accommodate these options: built in picnic table or bottom clubhouse.



Main photo features customized Dream® with wood roof, green wave slide, and monkey bars.



Built-in Picnic Table

The **Straight-Base Series** offers lots of activity and options, and these swing sets are a great choice if your property is sloped or uneven. There is no need to spend money on costly site preparation and landscaping services, as these swing sets use our unique leveling system. Our original and most popular design, these play sets offer the most activities beneath the play deck such as the built in picnic table or a fully enclosed bottom clubhouse.



Bottom Playhouse

Available in 5 1/2' and 6' deck heights with 8 1/2' and 9 1/2' swing beam heights.

Straight-Base Series
Dreamscape[®]
MODELS



Straight-Base Series
Dream[®]
MODELS



Straight-Base Series
Ultimate[®]
MODELS



Easy 1-2-3
Steel A-Frame
Bracket System

ENGINEERED HEAVY-DUTY
CONSTRUCTION

All swing beams and side supports are supported with *Easy 1-2-3 A-Frame Brackets*. Designed specifically for swing sets, these brackets are the strongest and safest support system on the market today! *Never rely on fasteners alone to support your swing set.*

Never Rely
on fasteners
alone to
support your
swing set!



Straight-Base Series
Dreamscape®
 MODELS

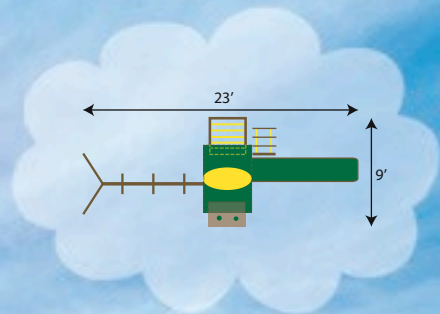

STANDARD
 MODEL



Dreamscape® Standard Features:



1 Gym Ring/
 Trapeze Bar



2 Sling Swings



Grab Handles



Steering Wheel



Telescope



Jacobs Ladder



8' 6" High
 3-Position
 Swing Beam



Straight Base
 Clubhouse



Tent Top



Rock Climbing
 Wall



Access Ladder
 with Steel Rungs



10' Wave Slide

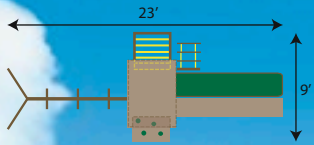

Customized Dreamscape®
with wood roof, gang plank,
and green wave slide.
(3 Total Swing Positions)



**Dreamscape®
Models Feature
8' 6" High
Swing Beam!**

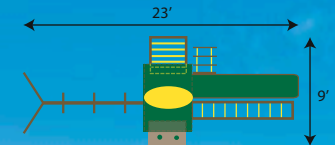

Customized Dreamscape®
with tent top,
yellow wave slide,
extra sling swing,
accessory arm,
monkey bars,
and built-in
picnic table.
(4 Total Swing
Positions)



Straight-Base Series
Dreamscape®
MODELS

Dreamscape® Standard Specs:

- 4 x 6 Swing Beam
- 4 x 4 Posts
- 4 x 6 and 4 x 4 Laminated Cedar Construction
- 100% Cedar
- 3-4 Total Swing Positions
- Heavy Duty Vinyl Tent Tops
- 5/8" Thick Braided Rope

**Dreamscape®
Overall Measurements:**

- Jungle Gym Footprint: 23' x 9'
- Swing Beam Height: 8 1/2'
- Play Deck Height: 5 1/2'
- Overall Height: 12'
- Clubhouse Dimensions: 55" x 39"
(6' clearance recommended on all sides around swing set).



Powder Coated
Ladder Rungs

Easy 1-2-3 Steel
A-Frame Bracket

Heavy Duty
Swing Hangers

Plastisol-Coated
Swing Chain



Creating Childhood Memories Since 1992!



Straight-Base Series
Dream[®]
MODELS

**STANDARD
 MODEL**

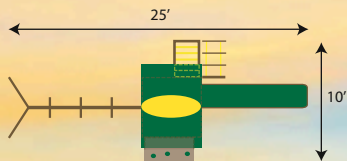

Dream[®] Standard Features:



1 Gym Ring/
Trapeze Bar



2 Sling Swings



Grab Handles



Deluxe
Ship's Wheel



Binoculars



Jacobs Ladder



8' 6" High
3-Position
Swing Beam



Straight Base
Clubhouse



Tent Top



Rock Climbing
Wall



Access Ladder
with Steel Rungs



10' Wave Slide



Dream®
Overall Measurements:

- Jungle Gym Footprint: 25' x 10'
- Swing Beam Height: 8 1/2'
- Play Deck Height: 5 1/2'
- Overall Height: 12'
- Clubhouse Dimensions: 55" x 58"
(6' clearance recommended on all sides around swing set).

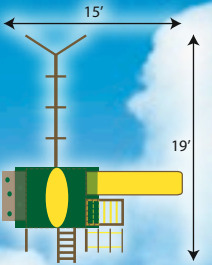

Straight-Base Series
Dream®
MODELS



Customized Dream® with tent top, yellow wave slide, extra sling swing, accessory arm, and step ladder with safety handles. (4 Total Swing Positions)

Customized Dream® with tent top, green wave slide, monkey bars, and built-in picnic table. (3 Total Swing Positions)

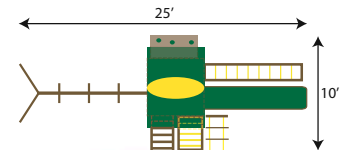

Customized Dream®
with tent top,
green wave slide,
extra sling swing,
accessory arm, step ladder
with safety handles,
and bottom playhouse.
(4 Total Swing Positions)



Dream®
Models Feature
8' 6" High
Swing
Beam!

Straight-Base Series
Dream®
MODELS

Customized Dream® with
wood roof, green wave
slide, and monkey bars.
(3 Total Swing Positions)

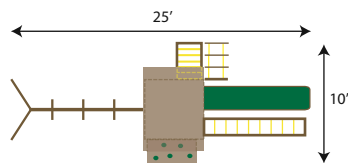

Dream® Standard Specs:

Powder Coated Ladder Rungs

Easy 1-2-3 Steel A-Frame Bracket

Heavy Duty Swing Hangers

Plastisol-Coated Swing Chain



- 3-4 Total Swing Positions
- Heavy Duty Vinyl Tent Tops
- 4 x 6 and 4 x 4 Laminated Cedar Construction
- 1" Thick Braided Rope
- 100% Cedar
- 4 x 6 Swing Beam
- 4 x 4 Posts

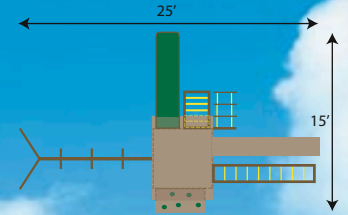

Customized Dream® with wood roof, green wave slide, monkey bars, gang plank, and built-in picnic table. (3 Total Swing Positions)

Customized Dream® with tent top, green wave slide, green 5' spiral slide, and built-in picnic table. (3 Total Swing Positions)

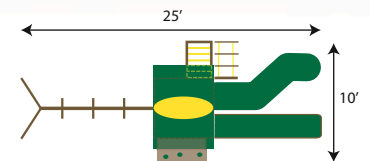

Straight-Base Series
Ultimate[®]
MODELS

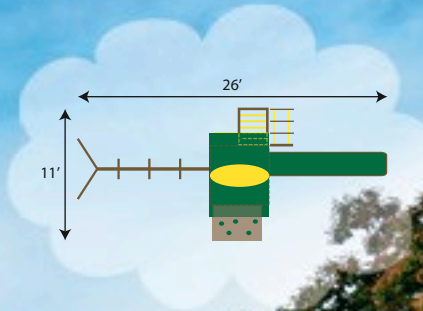

STANDARD
MODEL

Ultimate[®]
Models Feature
6' High Play Deck
and 9' 6" High
Swing Beam!

Ultimate[®] Standard Features:



- 1 Gym Ring/Trapeze Bar
- 2 Sling Swings
- Grab Handles
- Deluxe Ship's Wheel
- Binoculars
- Jacobs Ladder
- 9' 6" High 3-Position Swing Beam
- Straight Base Clubhouse
- Tent Top
- Rock Climbing Wall
- Access Ladder with Steel Rungs
- 12' Wave Slide

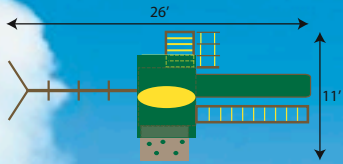

Customized Ultimate®
with tent top, 12' green wave slide, monkey bars, and built-in picnic table.
(3 Total Swing Positions)

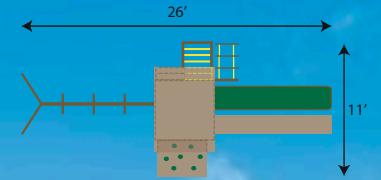

Customized Ultimate® with wood roof, 12' green wave slide, gang plank, and built-in picnic table.
(3 Total Swing Positions)



Straight-Base Series
Ultimate®
MODELS

Ultimate® Standard Specs:

- 3-4 Total Swing Positions
- 1" Thick Braided Rope
- Heavy Duty Vinyl Tent Tops
- 100% Cedar
- 4 x 6 and 4 x 4 Laminated Cedar Construction
- 4 x 6 Swing Beam
- 4 x 4 Posts

Powder Coated Ladder Rungs

Easy 1-2-3 Steel A-Frame Bracket

Heavy Duty Swing Hangers

Plastisol-Coated Swing Chain



Ultimate® Overall Measurements:

- Jungle Gym Footprint: 26' x 11'
- Swing Beam Height: 9 1/2'
- Play Deck Height: 6 1/2'
- Overall Height: 13 1/2'
- Clubhouse Dimensions: 55" x 58"



Creating Childhood Memories Since 1992!



Angled-Base Series

FUN For the Entire Family!

Using a unique A-frame design support system, these models can accommodate a 3-chain tire swing below the deck, saving space while providing another great swinging activity!



Main photo features customized Extreme® with wood roof, 12' green wave slide, and gang plank.



With the wide stance of the **Angled-Base Series**, a tire swing is the perfect accessory to go beneath the play deck — adding more fun without taking up any additional property! These wooden swing sets are very popular among families looking for a tire swing, an activity that accommodates up to three kids. The property needs to be somewhat level for these wood play sets, but a slight incline will still work. These models, with wider bases, are especially appealing to adventurous children who love to climb and explore!

Available in 5 1/2' and 6 1/2' deck heights with 8 1/2' and 9 1/2' swing beam heights.



Angled-Base Series
Supremescape®
 MODELS



Angled-Base Series
Supreme®
 MODELS



Angled-Base Series
Extreme®
 MODELS



**Easy 1-2-3
 Steel A-Frame
 Bracket System**

**ENGINEERED HEAVY-DUTY
 CONSTRUCTION**

All swing beams and side supports are supported with *Easy 1-2-3 A-Frame Brackets*. Designed specifically for swing sets, these brackets are the strongest and safest support system on the market today! *Never rely on fasteners alone to support your swing set.*

**Never
 Rely
 on fasteners
 alone to
 support your
 swing set!**



Angled-Base Series
Supremescape®
 MODELS

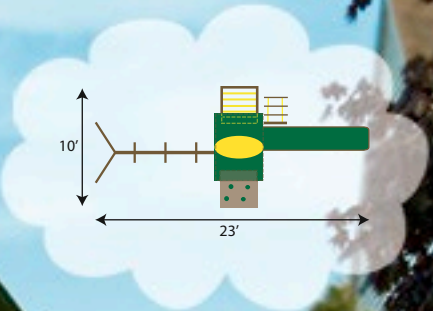

STANDARD
 MODEL



3-Chain
 Tire Swing

Supremescape® Standard Features:



1 Gym Ring/
 Trapeze Bar



2 Sling Swings



Grab Handles



Steering Wheel



Telescope



Jacobs Ladder



8' 6" High
 3-Position
 Swing Beam



Angled Base
 Clubhouse



Tent Top



Rock Climbing
 Wall



Wood Step Ladder
 with Handles



10' Wave Slide

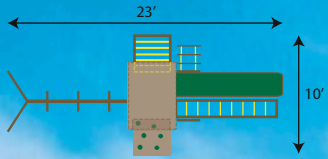

Supremescape®
Models Feature
8' 6" High
Swing
Beam!

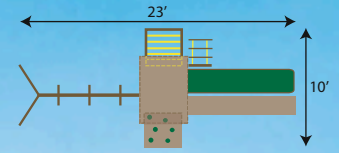

Customized
Supremescape® with
wood roof, green wave
slide, extra sling swing,
accessory arm, and
monkey bars.
(4 Total Swing
Positions)

Customized
Supremescape®
with wood roof,
green wave slide,
and gang plank.
(4 Total Swing
Positions)



Angled-Base Series Supremescape® MODELS

Supremescape® Standard Specs:

- 4 x 6 Swing Beam
- 4 x 4 Posts
- Double 2 x 6 Floor Joists
- 4 x 6 and 4 x 4 Laminated Cedar Construction
- 100% Cedar
- 4-5 Total Swing Positions
- Heavy Duty Vinyl Tent Tops
- 5/8" Thick Braided Rope

Supremescape® Overall Measurements:

- Jungle Gym Footprint: 23' x 10'
- Swing Beam Height: 8 1/2'
- Play Deck Height: 5 1/2'
- Overall Height: 12'
- Clubhouse Dimensions: 55" x 39"
(6' clearance recommended
on all sides around swing set)

Powder Coated
Ladder Rungs

Easy 1-2-3 Steel
A-Frame Bracket

Heavy Duty
Swing Hangers

Plastisol-Coated
Swing Chain



Creating Childhood Memories Since 1992!



Angled-Base Series
Supreme[®]
 MODELS

STANDARD
 MODEL

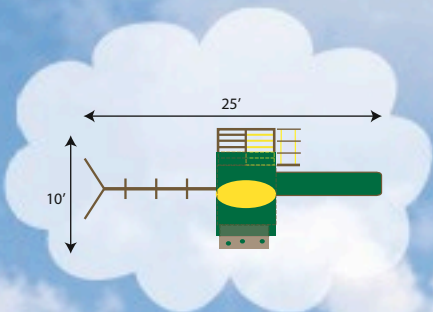

Combo Ladder with
 Steel Rungs and Wood Steps

Supreme[®] Standard Features:



3-Chain
 Tire Swing



1 Gym Ring/
 Trapeze Bar



2 Sling Swings



Grab Handles



Deluxe
 Ship's Wheel



Binoculars



Jacobs Ladder



8' 6" High
 3-Position
 Swing Beam



Angled Base
 Clubhouse



Tent Top



Rock Climbing
 Wall



10' Wave Slide

Customized Supreme®
with striped tent top,
green wave slide, and
monkey bars.
(4 Total Swing
Positions)

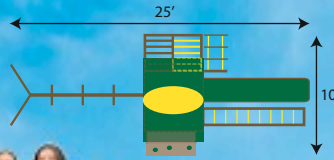

Customized Supreme®
with wood roof,
green wave slide,
and gang plank.
(4 Total Swing
Positions)

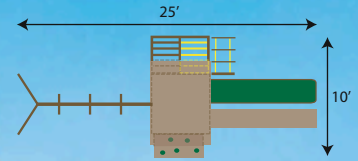

Customized Supreme®
with wood roof, green wave slide,
and green 5' spiral slide.
(4 Total Swing
Positions)

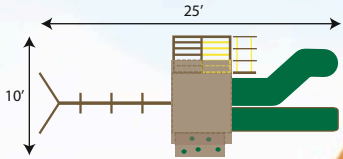

Supreme®

Overall Measurements:

- Jungle Gym Footprint: 25' x 10'
- Swing Beam Height: 8 1/2'
- Play Deck Height: 5 1/2'
- Overall Height: 12'
- Clubhouse Dimensions: 5' x 6'

Angled-Base Series Supreme® MODELS



Supreme® Standard Specs:

Powder Coated
Ladder Rungs

Easy 1-2-3 Steel
A-Frame Bracket

Heavy Duty
Swing Hangers

Plastisol-Coated
Swing Chain

- 4-5 Total Swing Positions
- 100% Cedar
- Double 2 x 6 Floor Joists
- 4 x 4 Posts
- 4 x 6 and 4 x 4 Laminated Cedar Construction
- 4 x 6 Swing Beam
- Heavy Duty Vinyl Tent Tops
- 5/8" Thick Braided Rope



Creating Childhood Memories Since 1992!



Angled-Base Series
Extreme[®]
 MODELS

STANDARD
 MODEL

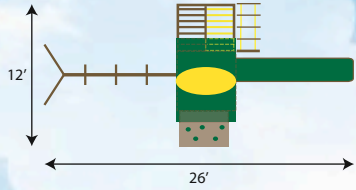

4" x 6" Combo Ladder with Steel Rungs and Wood Steps

Extreme[®] Standard Features:



3-Chain Tire Swing



1 Gym Ring/Trapeze Bar



2 Sling Swings



Grab Handles



Deluxe Ship's Wheel



Binoculars



Jacobs Ladder



9' 6" High 3-Position Swing Beam



4" x 6" Angled Base Clubhouse



Tent Top



Rock Climbing Wall



12' Wave Slide

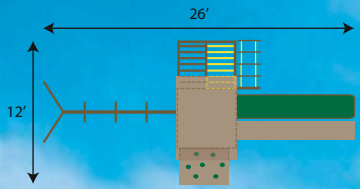

Customized Extreme®
with tent top, 12' green
wave slide, monkey bars,
extra sling swing, and
accessory arm.
(5 Total Swing
Positions)

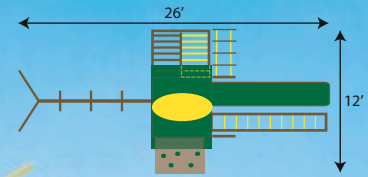

Customized Extreme®
with wood roof,
12' green wave slide,
and gang plank. (4 Total Swing Positions)

**Extreme®
Models Feature
6' 6" High Play
Deck and 9' 6"
High Swing
Beam!**



**Angled-Base Series
Extreme®
MODELS**

Extreme® Standard Specs:

- 4 x 6 Swing Beam
- 4 x 4 Posts
- Double 2 x 6 Floor Joists
- 4 x 6 and 4 x 4 Laminated Cedar Construction
- 100% Cedar
- 3-4 Total Swing Positions
- Heavy Duty Vinyl Tent Tops
- 1" Thick Braided Rope

Extreme® Overall Measurements:

- Jungle Gym Footprint: 26' x 12'
 - Swing Beam Height: 9 1/2'
 - Play Deck Height: 6 1/2'
 - Overall Height: 13 1/2'
 - Clubhouse Dimensions: 55" x 58"
- (6' clearance recommended on all sides around swing set)

Powder Coated Ladder Rungs

Easy 1-2-3 Steel A-Frame Bracket

Heavy Duty Swing Hangers

Plastisol-Coated Swing Chain



Creating Childhood Memories Since 1992!



Multi-Deck Series

These Swing Sets Have It ALL!



If you are looking for a bigger model with lots of options, these backyard swing sets have it all. The Multi-Deck Series jungle gyms feature a straight vertical structure, with multiple play decks. Bottom playhouses and built-in picnic tables are both options.



Built-in Picnic Table

The **Multi-Deck Series** is where you see all of our model designs combined, with lots of options and available accessories. These models feature straight vertical posts, and, like our standard straight-base series models, can accommodate a picnic table or bottom playhouse below the clubhouse. Choose from multiple play decks. With a range from two to five play decks, there's a swing set to fill every size backyard! With our multi-deck series swings sets the possibilities for outdoor fun are endless! Our largest line of wooden swing sets, these also work best on somewhat level ground.

Available in 5 1/2' and 7' deck heights with a swing beam height of 8 1/2'!



Bottom Playhouse

Multi-Deck Series
Sky[®] MODELS

Multi-Deck Series
Sky Tree House[®]
CABIN MODELS

Multi-Deck Series
Fantasy[®]
MODELS

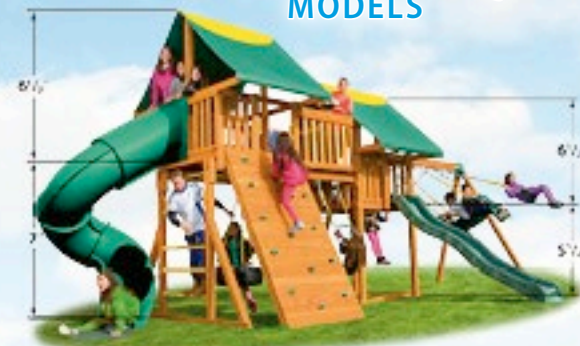

Multi-Deck Series
Fantasy Tree House[®]
CABIN MODELS

Multi-Deck Series
Imagination[®]
MODELS



Multi-Deck Series
Sky[®]
 MODELS

STANDARD
 MODEL

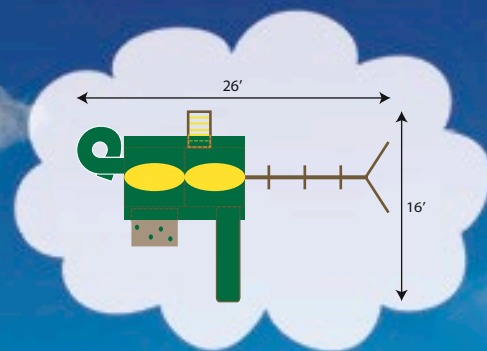

Sky[®] Standard Features:



1 Plastic Horse Glider



2 Sling Swings



Grab Handles



Deluxe Ship's Wheel



Binoculars



8' 6" High 3-Position Swing Beam



Double Clubhouse



Double Tent Top



Rock Climbing Wall



Access Ladder with Steel Rungs



10' Wave Slide



7' Spiral Slide



(6' clearance recommended on all sides around swing set).

Sky®

Overall Measurements:

- Jungle Gym Footprint: 26' x 16'
- Total Clubhouse Area: 2 clubhouses each 55" x 58"
- Play Deck Heights: 7' and 5' 6"
- Swing Beam Height: 8' 6"
- Overall Height: 13' 6"

Multi-Deck Series
Sky®
MODELS

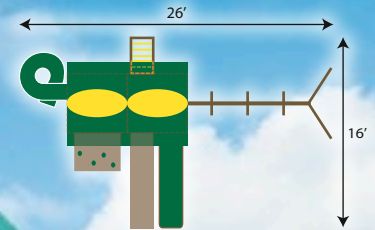

Customized Sky® with tent tops, green 7' spiral slide, green wave slide, gang plank, and built-in picnic table.

Customized Sky® with wood roofs, green 7' spiral slide, green 14' scoop slide, green wave slide, monkey bars, and built-in picnic table.

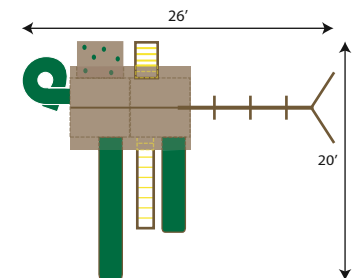

Multi-Deck Series
Sky[®]
MODELS

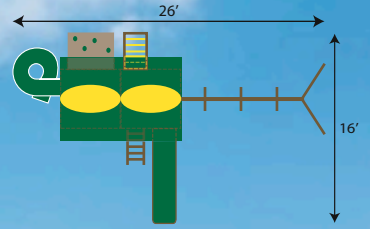

Customized Sky[®] with striped tent tops, green 7' spiral slide, wood step ladder, green wave slide, and bottom playhouse.

Sky[®] Models
Feature
8' 6" High
Swing
Beam!

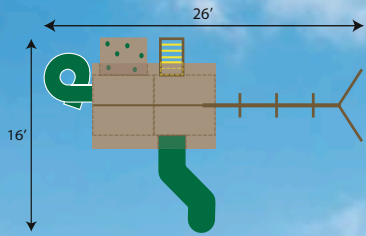

Customized Sky® with wood roofs, green 7' spiral slide, green 5' spiral slide, and bottom playhouse.

Sky® Standard Specs:

Powder Coated Ladder Rungs



Easy 1-2-3 Steel A-Frame Bracket



Heavy Duty Swing Hangers



Plastisol-Coated Swing Chain



- 3 Total Swing Positions
- 100% Cedar
- Heavy Duty Vinyl Tent Tops
- 4 x 6 Swing Beam
- 4 x 6 and 4 x 4 Laminated Cedar Construction
- 4 x 4 Posts

Multi-Deck Series

Sky®
MODELS



Creating Childhood Memories Since 1992!



Multi-Deck Series
Sky® Tree House
 CABIN MODELS

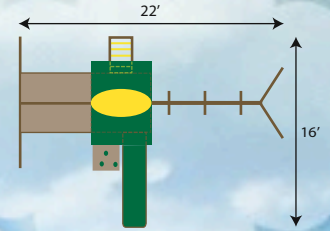

STANDARD
 MODEL

Sky®
 Tree House
 Cabin Models
 Feature 8' 6"
 High Swing
 Beam!

Sky® Tree House Cabin Standard Features:

- 
 Wood Roof &
 Chimney
- 
 Tree House with
 Front Porch
- 
 Binoculars
- 
 Grab Handles
- 
 Deluxe
 Ship's Wheel
- 
 Tent Top
- 
 Rock Climbing
 Wall
- 
 Access Ladder
 with Steel Rungs
- 
 10' Wave Slide
- 
 8' 6" High
 3-Position
 Swing Beam
- 
 1 Gym Ring/
 Trapeze Bar
- 
 2 Sling Swings

Sky® Tree House Cabin Overall Measurements:

- Jungle Gym Footprint: 24' x 16'
- Total Clubhouse Area:
2 clubhouses (1) 55" x 58"
and (1) 55" x 91"
- Play Deck Heights: 7' and 5' 6"
- Swing Beam Height: 8' 6"
- Overall Height: 13' 6"

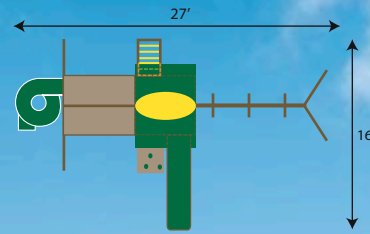

(6' clearance recommended on all sides around swing set)



Multi-Deck Series Sky® Tree House CABIN MODELS



Sky® Tree House Cabin Standard Specs:

Powder Coated
Ladder Rungs

Easy 1-2-3 Steel
A-Frame Bracket

Heavy Duty
Swing Hangers

Plastisol-Coated
Swing Chain

- 3 Total Swing Positions
- Heavy Duty Vinyl Tent Tops
- 4 x 6 and 4 x 4 Laminated Cedar Construction

- 100% Cedar
- 4 x 6 Swing Beam
- 4 x 4 Posts

Customized Sky® Tree House Cabin with tent top, green wave slide, and green open spiral slide.



Creating Childhood Memories Since 1992!



Multi-Deck Series Fantasy[®] MODELS

STANDARD
MODEL

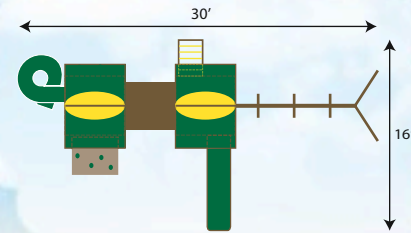

Green
7' Spiral Slide



Double Clubhouse with Double Tent
Top and Connecting Bridge

Fantasy[®] Standard Features:



Double Wide
Monkey Bar



Grab Handles



3-Chain
Tire Swing



Rock Climbing
Wall



Deluxe
Ship's Wheel



Binoculars



1 Gym Ring/
Trapeze Bar



Access Ladder
with Steel Rungs



10' Wave Slide



8' 6" High
3-Position
Swing Beam



1 Plastic
Horse Glider



2 Sling Swings



Fantasy® monkey bar detail

Customized Fantasy® with tent tops, green 7' spiral slide, green wave slide, gang plank, and built-in picnic table.

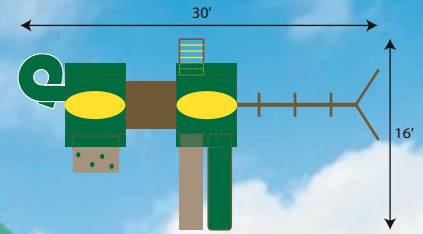

Multi-Deck Series
Fantasy®
MODELS

Customized Fantasy® with wood roofs, green 7' spiral slide, green 14' scoop slide, green wave slide, gang plank, and built-in picnic table.

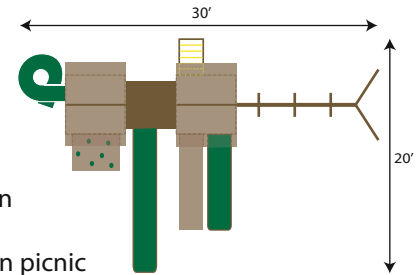



Fantasy® monkey bar detail

Multi-Deck Series
Fantasy®
 MODELS

Fantasy®
 Overall Measurements:

- Jungle Gym Footprint: 30' x 16'
- Total Clubhouse Area:
 2 clubhouses (1) 55" x 58"
 and (1) 55" x 111"
- Play Deck Heights: 7' and 5' 6"
- Swing Beam Height: 8' 6"
- Overall Height: 13' 6"

(6' clearance recommended
 on all sides around swing set).



Customized Fantasy®
 with wood roofs,
 green 7' spiral slide,
 green wave slide, and
 bottom playhouse.

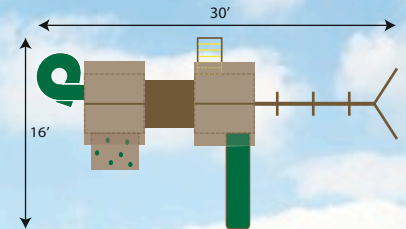

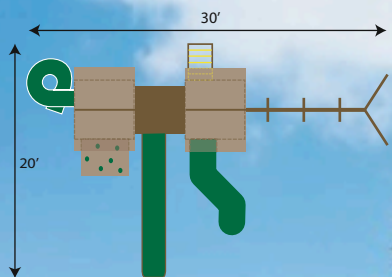

Multi-Deck Series
Fantasy[®]
 MODELS

Fantasy[®]
 Models Feature
 8' 6" High
 Swing
 Beam!



Fantasy[®] Standard Specs:

Powder Coated
Ladder Rungs

Easy 1-2-3 Steel
A-Frame Bracket

Heavy Duty
Swing Hangers

Plastisol-Coated
Swing Chain

- 5 Total Swing Positions
- Heavy Duty Vinyl Tent Tops
- 4 x 6 and 4 x 4 Laminated Cedar Construction

- 100% Cedar
- 4 x 6 Swing Beam
- 4 x 4 Posts

Customized Fantasy[®] with wood roofs, green 7' spiral slide, green 14' scoop slide, and green 5' spiral slide.



Creating Childhood Memories Since 1992!





Wood Roof & Chimney

Multi-Deck Series Fantasy® Tree House CABIN MODELS

STANDARD
MODEL

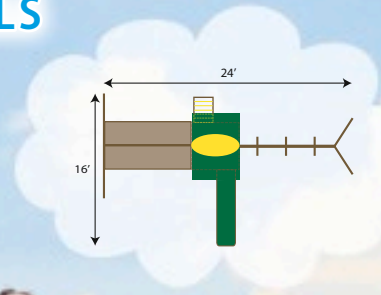

Fantasy® Tree House Cabin Standard Features:



Double Wide
Monkey Bar



Grab Handles



3-Chain
Tire Swing



1 Gym Ring/
Trapeze Bar



Binoculars



Deluxe
Ship's Wheel



Access Ladder
with Steel Rungs



Tent Top



10' Wave Slide



8' 6'' High
3-Position
Swing Beam



1 Plastic
Horse Glider



2 Sling Swings



Fantasy® Tree House Cabin

Overall Measurements:

- Overall Height: 13' 6"
- Swing Beam Height: 8' 6"
- Play Deck Heights: 7' and 5' 6"
- Total Clubhouse Area: 2 clubhouses (1) 55" x 58" and (1) 55" x 111"
- Jungle Gym Footprint: 24' x 16' (6' clearance recommended on all sides around swing set)



Fantasy® Tree House Cabin

Standard Specs:

Powder Coated Ladder Rungs



Easy 1-2-3 Steel A-Frame Bracket



Heavy Duty Swing Hangers



Plastisol-Coated Swing Chain



- 5 Total Swing Positions
- Heavy Duty Vinyl Tent Top
- 4 x 6 and 4 x 4 Laminated Cedar Construction
- 100% Cedar
- 4 x 6 Swing Beam
- 4 x 4 Posts

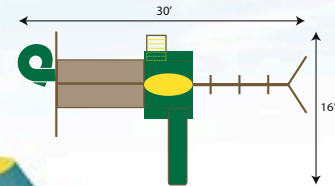
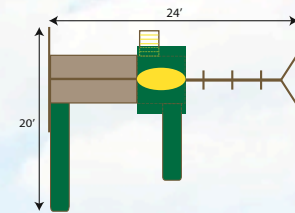

Fantasy®
Tree House
Cabin Models
Feature 8' 6"
High Swing
Beam!

Customized Fantasy® Tree House Cabin with tent top, green 14' scoop slide, and green wave slide.

Customized Fantasy® Tree House Cabin with tent top, green 7' spiral slide, and green wave slide.

Multi-Deck Series

Fantasy® Tree House

CABIN MODELS



Fantasy® Tree House Cabin
monkey bar detail



Creating Childhood Memories Since 1992!



Multi-Deck Series
Imagination®
 MODELS

STANDARD
 MODEL



Imagination® Standard Features:



Double Wide
 Monkey Bar



Grab Handles



3-Chain
 Tire Swing



1 Gym Ring/
 Trapeze Bar



2 Binoculars



2 Deluxe
 Ship's Wheels



2 Access Ladders
 with Steel Rungs



Rock Climbing
 Wall



Wood Roof
 & Chimney



1 Green
 Crawl Tube



7' Spiral Slide



3 Clubhouses with
 Tent Tops



Imagination® monkey bar detail



Imagination®
back view

Imagination®
Overall Measurements:

- Jungle Gym Footprint: 41' x 28'
- Total Clubhouse Area: 104 sq. ft.
- Play Deck Heights: 7' and 5' 6"
- Swing Beam Height: 8' 6"
- Overall Height: 13' 6"

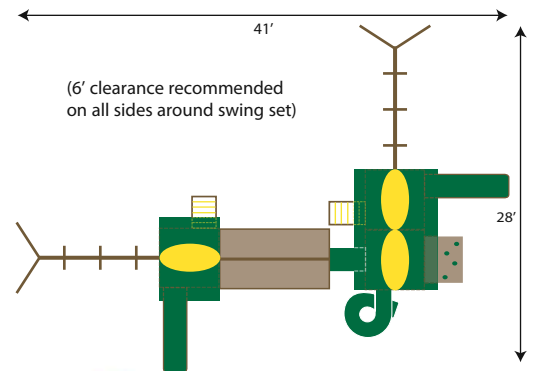

Two 10'
Wave Slides



Two 8' 6" High
3-Position
Swing Beams



2 Plastic
Horse Gliders



4 Sling Swings

Creating Childhood Memories Since 1992!



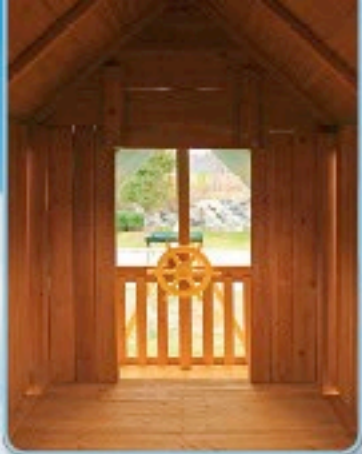

Imagination® Tree House
Back door detail



Imagination® Tree House
Front door detail

Imagination® Standard Specs:

Powder Coated
Ladder Rungs

Easy 1-2-3 Steel
A-Frame Bracket

Heavy Duty
Swing Hangers

Plastisol-Coated
Swing Chain



- 8 Total Swing Positions
- Heavy Duty Vinyl Tent Tops
- 4 x 6 and 4 x 4 Laminated Cedar Construction
- 100% Cedar
- 4 x 6 Swing Beam
- 4 x 4 Posts

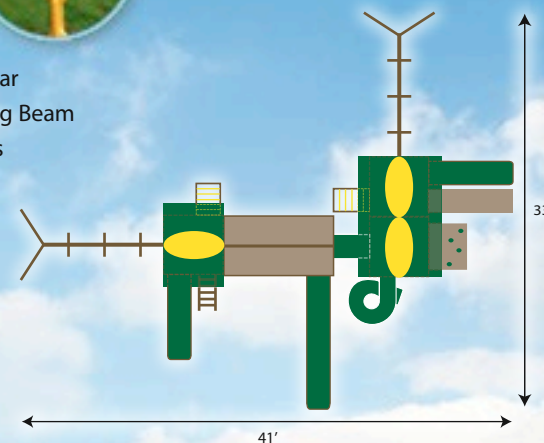

(6' clearance recommended
on all sides around swing set)

Multi-Deck Series Imagination® MODELS

Customized Imagination® with gang plank, built-in picnic table, green 14' scoop slide, wood step ladder, and bottom playhouse.



Imagination®
Models Feature
8' 6" High
Swing
Beam!

Free-Standing Series
Classic™
 MODELS



Classic™ Cedar Swing Set with 2 sling swings and gym-ring/trapeze bar combo.



Classic™ Bench Swing with full bucket (infant) swing and 4' adult bench swing.

Also Available in a Do It Yourself Kit!



Classic™ Tire Swing Three-chain tire swing; swings 360 degrees and fits 3 kids!



Classic™ Kids Swing with full bucket (infant) swing, 1 sling swing, and plastic horse glider.

Classic™
 Overall Measurements:

- Jungle Gym Footprint: 12' x 8'
- Swing Beam Height: 8'

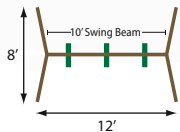

(6' clearance recommended on all sides around swing set).

Classic™ Standard Specs:

- 3 Total Swing Positions
- 100% Cedar
- 4 x 6 and 4 x 4 Laminated Cedar Construction
- 4 x 6 Swing Beam
- 4 x 4 Posts



Creating Childhood Memories Since 1992!



WOODEN Additions

Customize Your Jungle Gym With These Additions



6' Monkey Bars
(Extreme & Ultimate Models)



6' Gang Plank
(Extreme & Ultimate Models)



6' Step Ladder
with safety handles
(Extreme & Ultimate Models)



5' Step Ladder
with safety handles
(All Other Models)



Wood Roof
with Sunburst



Accessory Arm
(Swing sold separately)



Built-in Picnic Table
(Not available with Supreme,
Supremescape, or Extreme Models)



Bottom Playhouse
(Dream, Fantasy, Fantasy Tree House Cabin, and
Imagination Models) Includes floor & 4 walls.



Bottom Playhouse
(Ultimate Models) Includes floor & 4 walls.

Accessories & Slides



46" Steel Safety Handle
(See Step Ladder; p. 40)



9" Plastic Grab Handles



11" Plastic Steering Wheel



20" Deluxe Ship's Wheel



Jumbo Binoculars



Jumbo Telescope



3-Chain Tire Swing



Plastic Horse Glider



Full Bucket Swing (infant)



Half Bucket Swing (toddler)



Sling Swing



Gym Ring/ Trapeze Bar Combo



Tic-Tac-Toe Panel



Green 7' Open Spiral Slide



Green 7' Spiral Slide



Green 5' Spiral Slide



Green 14' Scoop Slide



Green 12' Wave Slide



Green 10' Scoop Slide



Green 10' Wave Slide



Dinner Bell

EASTERN JUNGLE GYM® SWING SETS Can Be Installed Almost *Anywhere!*

There's no need for costly site preparation...

Our exclusive leveling system was developed through more than 30 years of installation experience. This unique, time-proven leveling system ensures safe installation on un-level properties.*

* Eastern Jungle Gym models with an A-frame design do require a level area for installation.

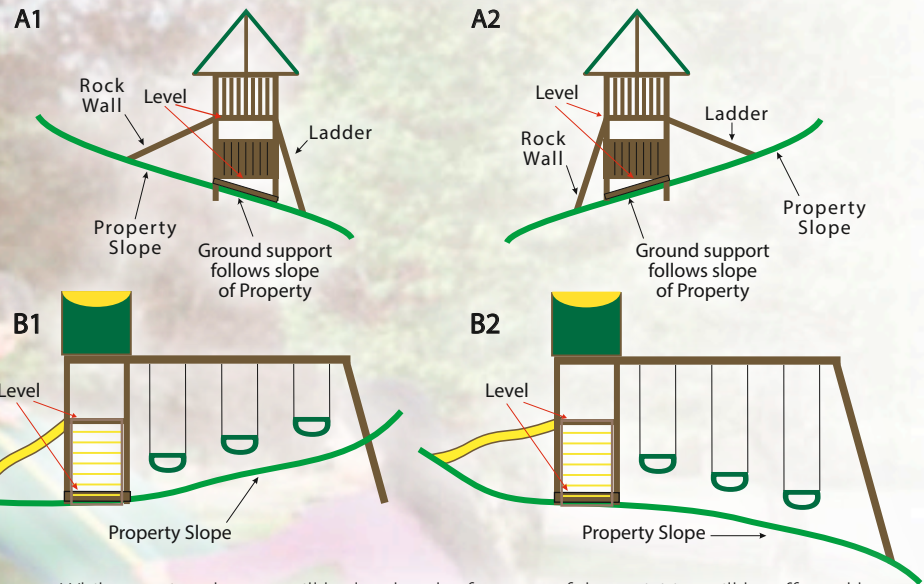

While your jungle gym will be level and safe, some of the activities will be affected by the sloping property (notice Rock Wall vs. Ladder in Diagrams A1 and A2). For example, if your slide is facing downhill (or uphill), it will be at a steeper angle (or more shallow angle) than normal; therefore it will be faster (or slower) (Diagrams B1 and B2). If your swing beam is installed downhill (or uphill), the swing position closest to the end will be lower to (or further from) the ground (Diagrams B1 and B2).

To determine play area size, it is recommended that you add six feet to the jungle gym dimension on all sides. However, beside swing beam side supports and other low traffic areas, it is not critical to have a six foot "play" area. Installing a resilient surfacing under the jungle gym is always recommended, and can be done AFTER your jungle gym is installed.

Questions AND ANSWERS

- Q.** What kind of wood does Eastern Jungle Gym® use?
A. Eastern Jungle Gym® uses only *100% Cedar* (C. laniolata).
- Q.** Is there any chemical treatment used to preserve the wood?
A. NO! Cedar is *naturally resistant* to rot and insect damage.
- Q.** How much maintenance is required for the Jungle Gym?
A. All Eastern Jungle Gyms® are *pre-stained* from the factory. However, we do recommend future applications be applied to maintain the wood's natural beauty.
- Q.** Are surface cracks and checking in the wood normal?
A. Yes! It is a natural characteristic of any outdoor wood product and will not affect the structural integrity of the jungle gym.
- Q.** How much weight will the Jungle Gym support?
A. Eastern Jungle Gyms® can support as many children (and adults) as you can fit on them!
- Q.** What if we move after our jungle gym is installed?
A. All Eastern Jungle Gyms® are *movable*. They can be disassembled and then reassembled at your new home. (Ask your rep for details).
- Q.** My yard is not level. Can I still install an Eastern Jungle Gym®?
A. Yes! We have a *unique leveling system* which enables us to customize our jungle gyms to accommodate most property conditions. (Our angled base sets do require a level area.)
- Q.** Will the slide get hot from the sun?
A. All slides and accessories are made with *U.V. Protectors* which help to inhibit the absorption of the sun's heat and also help to prevent the color from fading. However, darker-colored slides will retain more heat.
- Q.** How are your Jungle Gyms anchored?
A. All Eastern Jungle Gyms utilize a *unique ground support system* which distributes weight evenly to ensure strength and stability. Stakes are provided for the side supports as an added precaution.
- Q.** Are Eastern Jungle Gyms expandable?
A. Yes! All models can be customized and added onto after installation so they grow with your family.
- Q.** Can I get Monkey Bars with swings on them?
A. No. The Consumer Product Safety Commission and ASTM no longer allow swing sets be designed with swings attached to monkey bars. (ASTM F1148)
- Q.** How can I find out more about Eastern Jungle Gym®?
...How do I order one?
A. Call your *local representative*, who will be happy to answer any questions you may have, and to assist you in placing your order. Visit our web site at www.easternjungle gym.com for a location nearest you.

10-Year & 1-Year *Warranty*

For a pro-rated period of **TEN YEARS** from the date of purchase, Eastern Jungle Gym® warrants to the original purchaser all wooden components against structural failure due to insect infestation or wood rot. Seasonal checks, minor cracking, knots, knot holes, peeling and warping are considered a natural characteristic of wooden components and do not result in structural failure and are not covered under this warranty. Any components that are returned to Eastern Jungle Gym® under this limited ten year warranty will be replaced or repaired at our option. Any cost associated with work that must be performed on site is not covered. All travel and labor expenses or shipping and handling expenses, if any, will be the responsibility of the original purchaser. The warranty described in this paragraph is the original purchaser's sole and exclusive remedy and lasts for ten years or until original customer sells or otherwise transfers the unit.

All warranties are subject to proper installation and normal residential use. Eastern Jungle Gym® warrants to original purchaser that, for a period of **ONE YEAR** from date of purchase, and subject to the limitations stated below, all chains, rope, tent tops, seats, hardware, metal braces, handles, rungs and all accessories will be free from defects in material and workmanship. Cracks in plastic components are not considered defects in workmanship or material if they do not affect the functionality of component or jungle gym. Any components that are returned to Eastern Jungle Gym® under this limited one year warranty will be replaced or repaired at our option. Any cost associated with work that must be performed on site is not covered. All travel and labor expenses or shipping and handling expenses, if any, will be the responsibility of the original purchaser. The warranty described in this paragraph is the original purchaser's sole and exclusive remedy and lasts for one year or until original customer sells or otherwise transfer the unit.

Non-residential use of swing set is prohibited and will have no warranty as the swing sets are designed for residential use **ONLY**. Eastern Jungle Gym® reserves the right to examine photographs and/or physical evidence of merchandise claimed to be defective and to recover merchandise prior to any warranty claims. All merchandise returned for inspection must be sent freight pre-paid unless return authorization number is issued. This warranty does not apply to any swing set 1) subjected to abuse, vandalism, improper installation, negligence or acts of God. 2) Any alterations, additions, or relocation of the swing set by the customer or third party voids warranty. Failure to maintain your equipment properly—including, without limitation and by way of example only, not staining the unit or not checking and tightening the hardware—may cause the warranties described herein not to apply in certain circumstances.

This warranty is expressly in lieu of all other warranties; it excludes all consequential damages. Some states do not allow the limitation or exclusion of consequential damages, so the above may not apply to you. Eastern Jungle Gym® does not authorize any person or representative to express or imply any other warranty.

NOTICE: The wooden components in your Eastern Jungle Gym® will have imperfections. We would like to remind you that seasonal checking, surface cracks, knots, and knot holes are natural characteristics of all wooden swing sets. These imperfections that are not resulting in structural failure are NOT covered under this warranty.

Eastern Jungle Gym® reserves the right to make changes or modifications to products.

Independent Dealer:



About Us

AND OUR MISSION

From our humble beginning back in 1992 as a family venture in a small shed with two employees, to our current facility with over 30,000 square feet, we've maintained one core philosophy—***Build a safe, strong set that will last for years and sell it at a reasonable price.***

It's been over 30 years, and we're still family owned and operated, but now we have lots of help! Over the years, we've developed new designs to keep up with the ever-changing demands. We've also pioneered engineering feats, including our Easy 1-2-3 steel bracket system and laminated cedar construction.

With over 30 years of ***Creating Childhood Memories*** we strive to build a safe, strong and high quality swing set that will last for years. We are committed to maintaining the highest standards of value, service and integrity.

Today it's more important than ever to keep your children healthy and happy. There's no better way than to get them outside playing! We thank you for considering an Eastern Jungle Gym swing set and hope that we can help your family start ***creating their own childhood memories!***

Follow us Online at
easternjunglegym.com

